

Kabelvagnar

C-PROFILSKENA

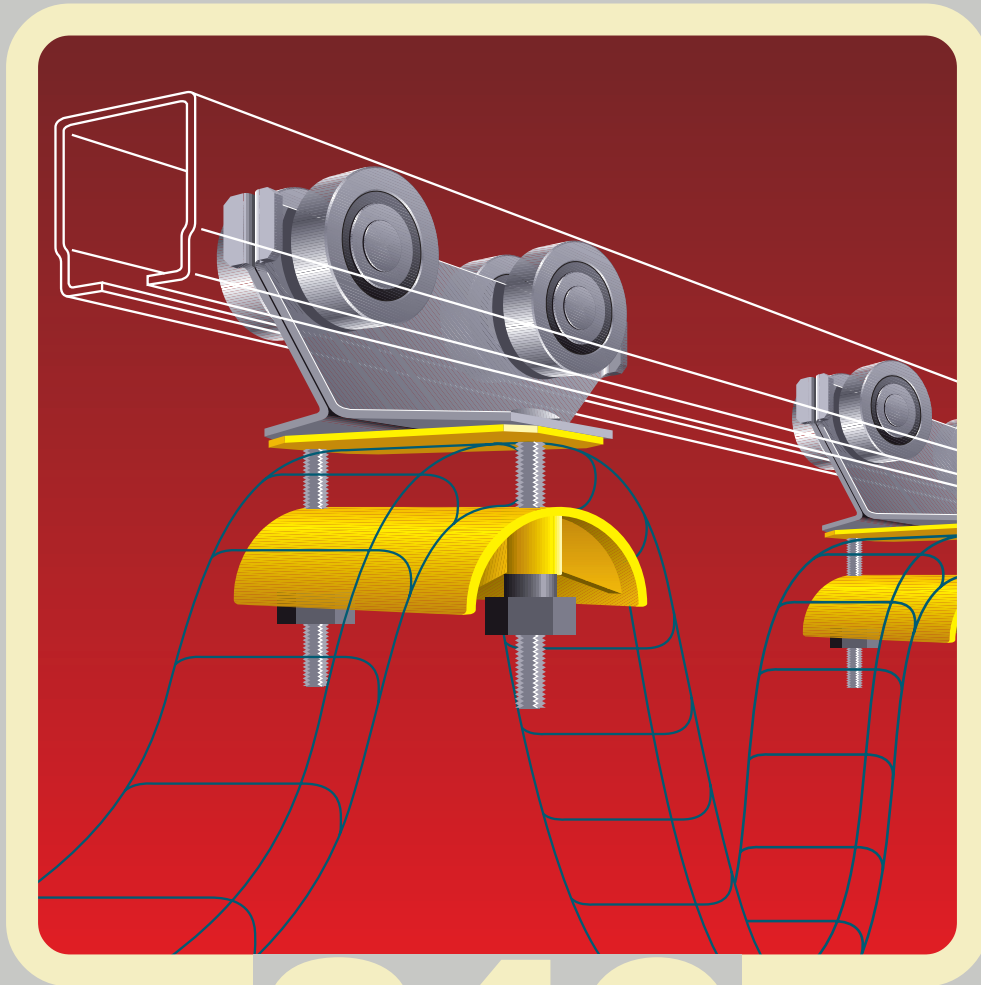

240

40 x 40 mm

wampfler
solutions for a moving world

C-profilskenor och tillbehör

C-profilskenor

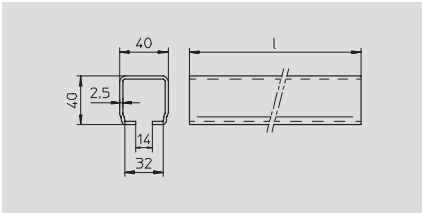
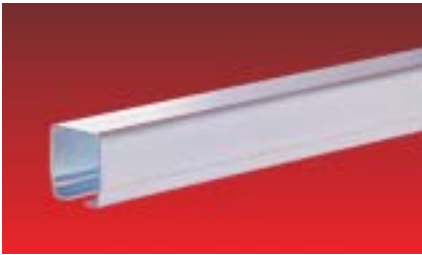

Art.nr	Längd l [mm]	Stat. värde
024100-6	6000	$I_x = 6,74\text{cm}^4$
024100-4	4000	$W_x = 3,08\text{cm}^3$

Material: Galv. stål
Andra längder samt kurvor, se huvudkatalog

Skenhållare

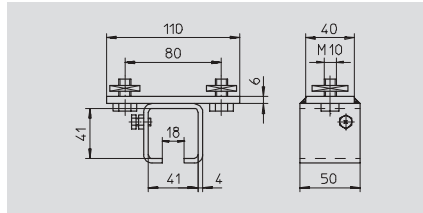

Art.nr	Utförande
024121	Utan skruvar och 4-kantmuttrar
024122	Med skruvar och 4-kantmuttrar

Material: Galv. stål
Max last: 250 kg

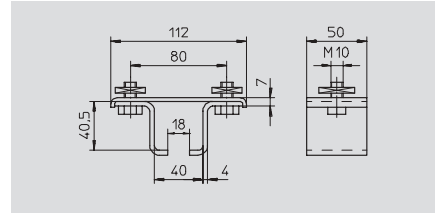

Art.nr	Utförande
024152	Utan skruvar och 4-kantmuttrar
024154	Med skruvar och 4-kantmuttrar

Material: Galv. stål
Max last: 100 kg

Skarvstycke

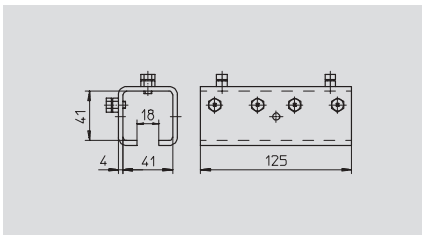

Art.nr: 024105
Material: Galv. stål

Skenhållare

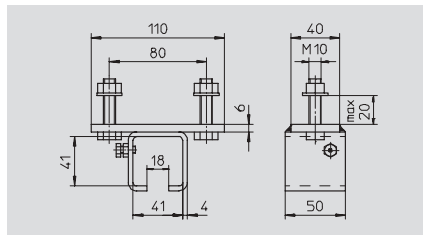

Art.nr: 024123
Material: Galv. stål
Max last: 250 kg

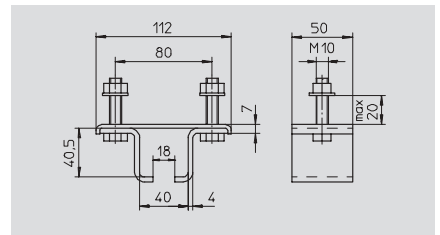

Art.nr: 024156
Material: Galv. stål
Max last: 100 kg

Konsoler och balkklämmor

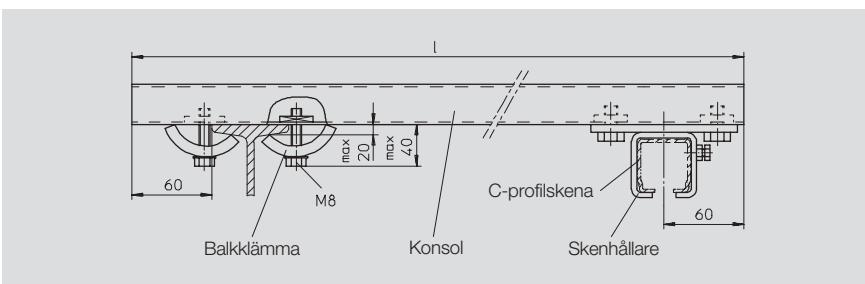

Benämning	Art.nr	l [mm]
Konsol	020276-0500	500
Konsol	020276-1000	1000
Balkklämma	020180-08	

Material: Galv. stål
Konsoler för montering under balk,
se huvudkatalog Program 240.

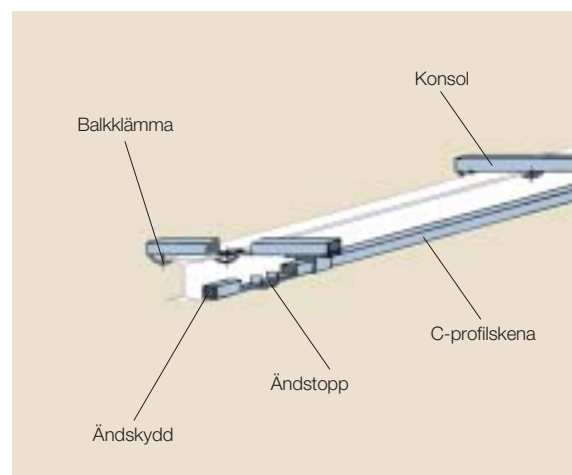

C-profilskenor och tillbehör

CI-profilskena

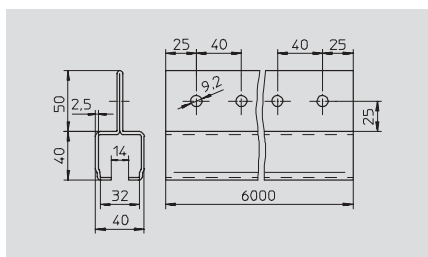

Art.nr: 024050-6
 Material: Galv. stål
 Stat. värde: $I_x = 37,16 \text{ cm}^4$
 $W_x = 7,53 \text{ cm}^3$
 För större upphängningsavstånd.

Skenhållare

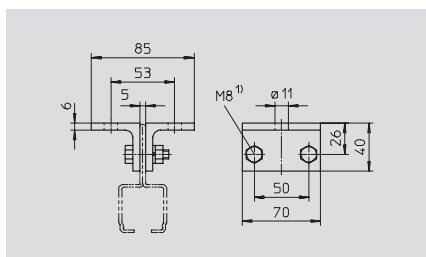

Art.nr: 024070
 Material: Galv. stål
 Max last: 250 kg

1) 2 st 9 mm hål borras i CI-skenan med cc 50 mm

Skarvstycke

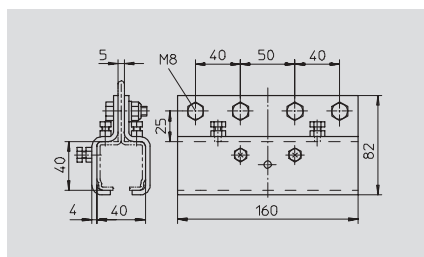

Art.nr: 024060
 Material: Galv. stål

Ändskydd

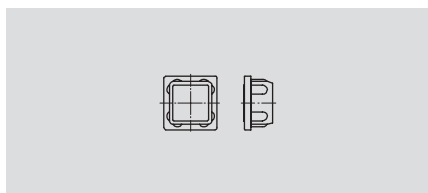

Art.nr: 020662-40
 Material: Plast

Ändstopp

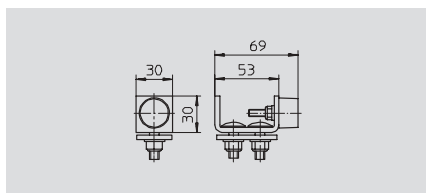

Art.nr: 024110 utan gummibuffert
Art.nr: 024111 med gummibuffert
 Material: Galv. stål

Kombi-skarvstycke

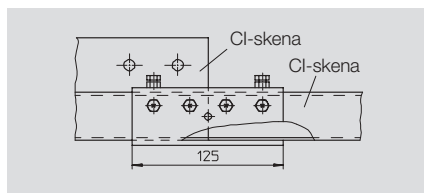

Art.nr: 024061
 Material: Galv. stål
 Kombi-skarvstycket användes vid övergång från CI-skena till vanlig C-skena.

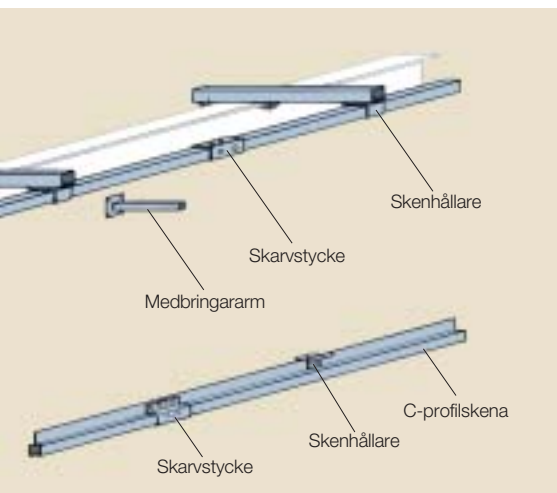

Medbringarm

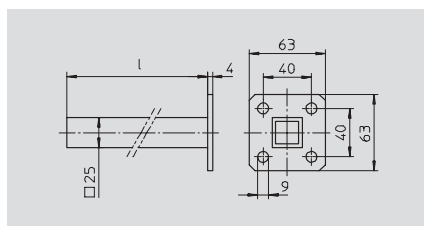

Art.nr	Längd l [mm]
020195-400	400
020195-630	630

Material: Galv. stål

Plattkabelvagnar

Kabelvagnar av stål - Kabelklämma av plast eller stål

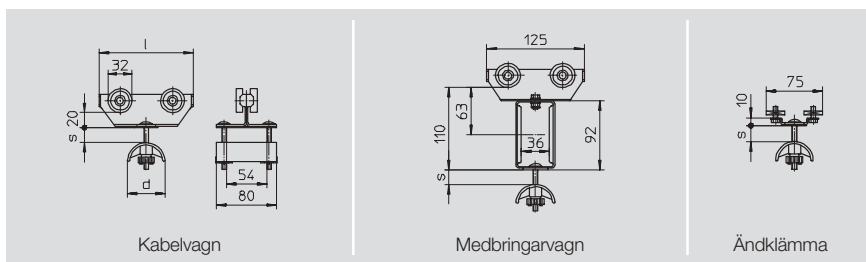

Kabelvagn Art.nr	Medbringarvagn Art.nr	Ändklämma Art.nr	d [mm]	l [mm]	s [mm]	Material Kabelklämma	Hjultyp	Last P [kg]
024246	024256	023269	50	80	15	Plast	Plasthjul med glidlager	12,5
024240-80	024250	023269	50	80	15	Plast	Stålkullager, Galv. Tätning: 2 Z	32
024240	024250	023269	50	125	36			
024241	024251	023279	80	125	22			

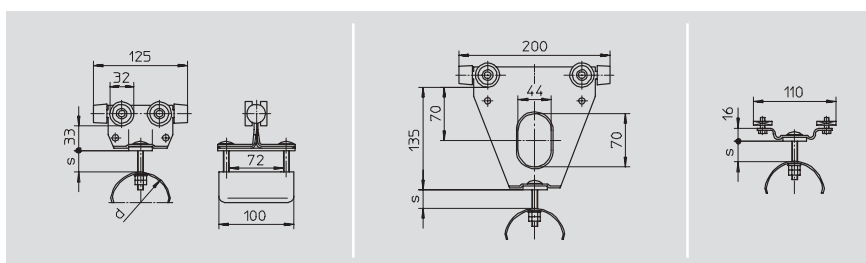

Kabelvagn Art.nr	Medbringarvagn Art.nr	Ändklämma Art.nr	d [mm]	s [mm]
024269-125x100	024279-200x100	024289-100x038	50	35
024270-125x100	024280-200x100	024290-100x038	80	20

Kabelklämma: Galv. stål
Hjul: Stålkullager, Galv.
Tätning: 2 Z
Last: 32 kg

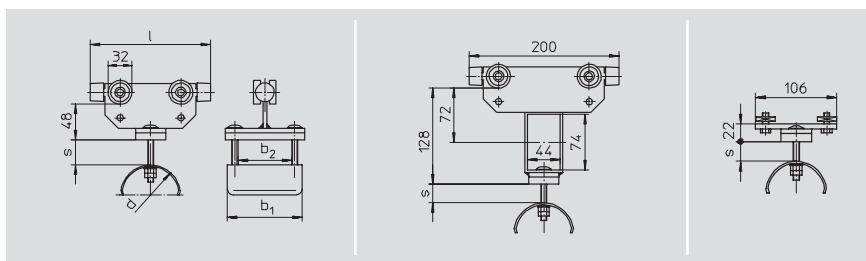

Kabelvagn Art.nr	Medbringarvagn Art.nr	Ändklämma Art.nr	d [mm]	l [mm]	b ₁ [mm]	b ₂ [mm]	s [mm]
024210-125x100	024220-200x100	024230-100x062	80	125	100	72	20
024210-125x160	024220-200x160	024230-160x062			160	132	
024210-160x100	024220-200x100	024230-100x062		160	100	72	38
024210-160x160	024220-200x160	024230-160x062				160	
024210-200x100	024220-200x100	024230-100x062	200	100	72	58	
024210-200x160	024220-200x160	024230-160x062			160		132
024212-160x100	024222-200x100	024232-100x042	125	160	100	72	15
024212-160x160	024222-200x160	024232-160x042			160	132	
024212-200x100	024222-200x100	024232-100x042		200	100	72	35
024212-200x160	024222-200x160	024232-160x042				160	

Kabelklämma: Galv. stål
Hjul: Stålkullager, Galv.
Tätning: 2 Z
Last: 32 kg

Kabelvagnar med specialhjul

Specialhjul Art.nr	Hjul Typ	Tätning	Last P [kg]
...../010 ¹⁾	Stålkullager, Galv.	2 RS	32
...../017 ¹⁾	Stålkullager, Galv. Yttering av Polyurethane Mycket tystgående	2 RS	20

1) Komplettera den ordinarie vagnens art.nr med tilläggsnumret.

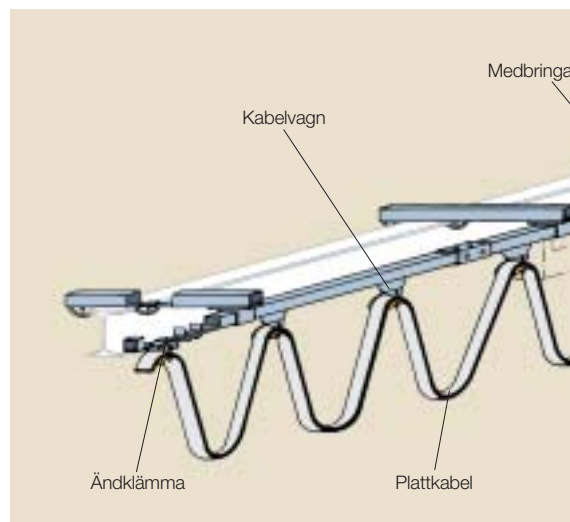

Plattkabelvagnar

Gummiplattkabel

Typ	Ledarantal och area [mm ²]	Art.nr	Max. dimension s x b [mm]	Vikt [kg / 100 m]
NGFLGÖU-J	4x1,5	0401- 4X1,5	6,4 x 18,5	20
NGFLGÖU-J	5x1,5	0401- 5X1,5	6,4 x 21,5	24
NGFLGÖU-J	8x1,5	0401- 8X1,5	6,4 x 32,0	35
NGFLGÖU-J	10x1,5	0401-10X1,5	7,0 x 41,5	50
NGFLGÖU-J	12x1,5	0401-12X1,5	7,0 x 48,5	59
NGFLGÖU-J	4x2,5	0401- 4X2,5	8,2 x 23,0	29
NGFLGÖU-J	5x2,5	0401- 5X2,5	8,2 x 28,5	42
NGFLGÖU-J	8x2,5	0401- 8X2,5	8,2 x 42,0	55
NGFLGÖU-J	10x2,5	0401-10X2,5	8,8 x 54,5	83
NGFLGÖU-J	12x2,5	0401-12X2,5	8,8 x 58,0	86
NGFLGÖU-J	4x4	0401- 4X4	9,6 x 28,0	41
NGFLGÖU-J	7x4	0401- 7X4	9,6 x 44,0	71
NGFLGÖU-J	4x6	0401- 4X6	10,4 x 30,0	52
NGFLGÖU-J	4x10	0401- 4X10	12,1 x 36,0	80
Gummi-plattkabel med individuellt skärmade ledare				
GCFLGÖU-O	4x1,5	0404- 4X1,5	7,4 x 19,5	25
GCFLGÖU-O	8x1,5	0404- 8X1,5	7,4 x 37,3	51

PVC-plattkabel

Typ	Ledarantal och area [mm ²]	Art.nr	Max. dimension s x b [mm]	Vikt [kg / 100 m]
H07VWH6-F	4G1,5	0325- 4G1,5	5,2 x 15,5	15,3
H07VWH6-F	5G1,5	0325- 5G1,5	5,2 x 18,5	18,5
H07VWH6-F	8G1,5	0325- 8G1,5	5,2 x 31,0	29,7
H07VWH6-F	10G1,5	0325-10G1,5	5,2 x 37,0	36,2
H07VWH6-F	12G1,5	0325-12G1,5	5,2 x 41,5	42,8
H07VWH6-F	4G2,5	0325- 4G2,5	5,9 x 19,0	22,4
H07VWH6-F	5G2,5	0325- 5G2,5	5,9 x 22,5	26,9
H07VWH6-F	8G2,5	0325- 8G2,5	5,9 x 38,0	43,7
H07VWH6-F	10G2,5	0325-10G2,5	5,9 x 45,0	53,4
H07VWH6-F	12G2,5	0325-12G2,5	5,9 x 52,0	62,8
H07VWH6-F	4G4	0325- 4G4	7,1 x 22,0	31,0
H07VWH6-F	7G4	0325- 7G4	7,1 x 38,0	53,7
H07VWH6-F	4G6	0325- 4G6	7,8 x 25,0	41,5
H07VWH6-F	4G10	0325- 4G10	9,9 x 31,5	68,0
H07VWH6-F	4G16	0325- 4G16	11,2 x 36,5	99,0
PVC-plattkabel med individuellt skärmade ledare				
YCFLY-O	4x1	0320- 4X1	5,0 x 13,9	13,1
YCFLY-O	8x1,5	0320- 8X1,5	6,0 x 32,4	37,5
YCFLY-O	12x1,5	0320-12X1,5	5,9 x 52,0	61,0

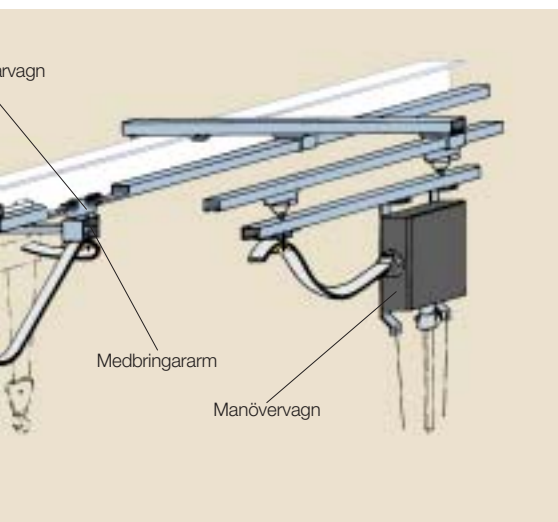

Plattkabelförskruvningar och kontramuttrar

Storlek	Plattkabel-förskruvning Art.nr	För kabeldimension sxb [mm]				Kontramutter Art.nr
		min.	max.	min.	max.	
Pg 16	020626-16	4,0	5,5	13	15	020657-16
Pg 21	020626-21	4,5	7,5	14	20,5	020657-21
Pg 29	020626-29	4,5	9,5	19	27,5	020657-29
Pg 29	020626-29S	4,5	9,5	19	29	020657-29
Pg 36	020626-36	4,5	13,5	29	34,5	020657-36
Pg 36	020626-36S	4,5	13,5	29	39	020657-36
Pg 42	020626-42	4,5	14,5	38	40,5	020657-42
Pg 42	020626-42S	4,5	14,5	38	45	020657-42
Pg 48	020626-48S	5,5	19,5	44	52	020657-48
Pg 48	020626-48	6,0	9,0	54	62	020657-48

Material: Förmicklad mässing; tryckbricka av förzinkad plåt; tätning av oljebeständigt gummi.

Förskruvningar i plast, se huvudkatalog 130 (kablar).

Rundkabelvagnar

Kabelvagnar av stål med kullänk

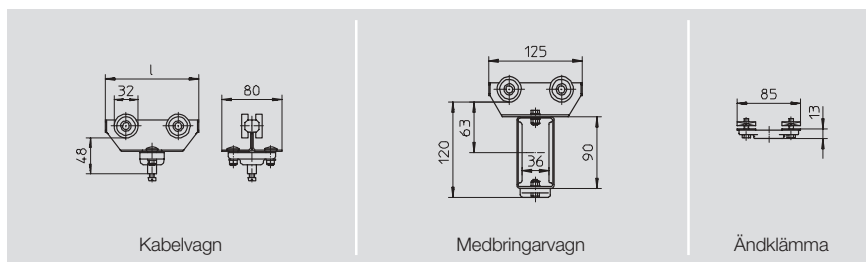

Kabelvagn Art.nr	l [mm]	Medbringarvagn Art.nr	Ändklämma Art.nr	Hjultyp	Last P [kg]
024303	80	024304	024312	Plasthjul med glidlager	12,5
024313-80	80	024314	024312	Stålkullager, Galv. Tätning: 2 Z	32
024313	125				

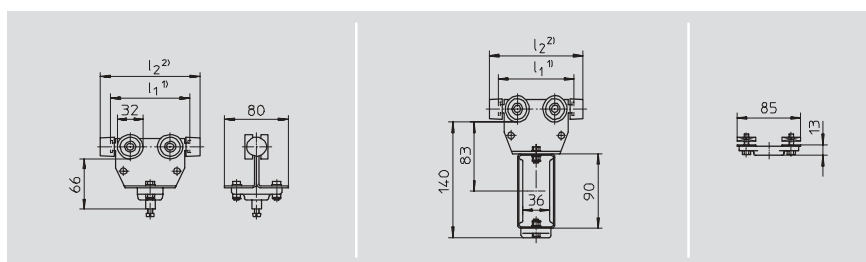

Kabelvagn			Medbringarvagn			Ändklämma Art.nr
Art.nr	l ₁ [mm]	l ₂ [mm]	Art.nr	l ₁ [mm]	l ₂ [mm]	
024306-100	100	-	024307-100	100	-	024312
024306-125	-	125	024307-125	-	125	

1) Vagn utan buffert 2) Vagn med buffert

Hjul: Stålkullager, Galv.
Tätning 2 Z
Last: 32 kg

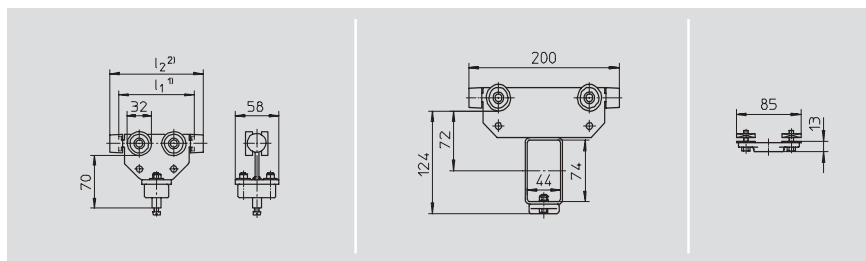

Kabelvagn			Medbringarvagn Art.nr	Ändklämma Art.nr
Art.nr	l ₁ [mm]	l ₂ [mm]		
024310-100	100	-	024311	024312
024310-125	-	125		
024310-160	-	160		

1) Vagn utan buffert 2) Vagn med buffert

Hjul: Stålkullager, Galv.
Tätning 2 Z
Last: 32 kg



Kabelklämma Art.nr	Kabeldiameter [mm]
020131-16	10 - 16
020131-25	17 - 25
020131-36	26 - 36

Flera kabelklämmor kan monteras på samma vagn. Användes olika storlekar, monteras den större klämman överst.

Kabelvagnar med specialhjul

Specialhjul Art.nr	Typ		Tätning	Last P [kg]
	Hjul			
...../010 ³⁾	Stålkullager, Galv.		2 RS	32
...../017 ³⁾	Stålkullager, Galv. Ytterring av Polyurethane Mycket tystgående		2 RS	20

3) Komplettera den ordinarie vagnens art.nr med tilläggsnumret.

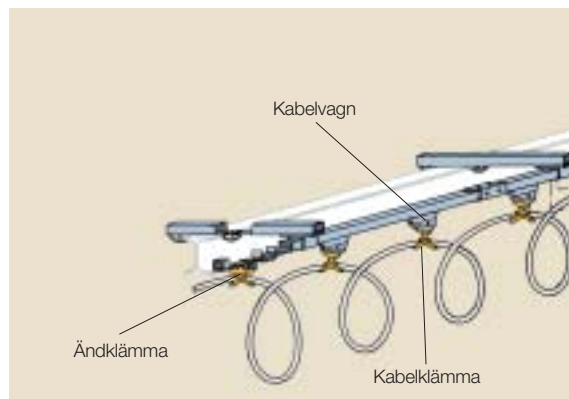

Rundkabelvagnar

Stålvagn med bygel

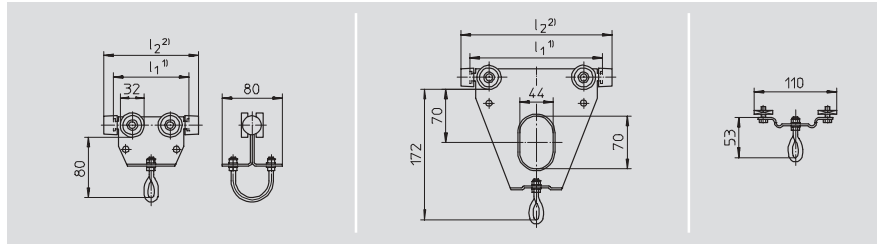

Leitungswagen			Mitnehmerwagen			Endklemme Bestell-Nr.
Bestell-Nr.	l ₁ [mm]	l ₂ [mm]	Bestell-Nr.	l ₁ [mm]	l ₂ [mm]	
024316-100	100	-	024317-175	175	-	024318
024316-125	-	125	024317-200	-	200	
024320-100 ³⁾	100	-	024321 ³⁾	-	200	024322 ³⁾
024320-125 ³⁾	-	125				
024320-160 ³⁾	-	160				

- 1) Vagn utan buffert
- 2) Vagn med buffert
- 3) Svetsat utförande. Vagnens överdel lika som vagn 024310 resp 024311 på sid 6.

Hjul: Stålkullager, Galv.; Tätning 2 Z
Last: 32 kg



Kabelklämma Art.nr	Kabeldiameter [mm]
020133-16	10 - 16
020133-25	17 - 25
020133-36	26 - 36

Om flera kablar ska monteras, kompletteras kabelklämma 020133 med kabelklämma typ 020131 (se sid 6).

Plastvagn med S-krok



Kabelvagn
Art.nr 024505
Plasthjul
med glidlager
Last: 10 kg

Ändklämma
Art.nr 020219



Kabelklämma		Kabelklämma	
Art.nr	ø [mm]	Art.nr	ø [mm]
020111-10	10	020111-20	20
020111-11	11	020111-22	22
020111-12,5	12,5	020111-25	25
020111-14	14	020111-28	28
020111-16	16	020111-32	32
020111-18	18	020111-36	36

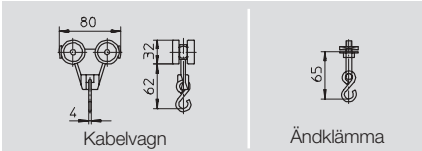

Rem
Art.nr: 020117-080
Rem för max. 80 mm.
Lämplig för slangar.

Kabelklämma

Rundkabel av gummi

Tryckluftslang

Art.nr	Slang		Max bel. vid 20°C [bar]
	innerdiam [mm]	yttre diam [mm]	
040421-1	6	12	23
040421-2	9	15	19
040421-3	12	21	16

Material: Klar PVC med textilstärkning;
olja- och bensinbeständig.

Typ	Ledarantal och area [mm ²]	Art.nr	Ytterdiameter min. - max. [mm]	Vikt [kg / 100 m]
H07RN-F	4G1,5	0601- 4G1,5	10,5 - 13,5	21
H07RN-F	4G2,5	0601- 4G2,5	12,5 - 15,5	30
H07RN-F	4G4	0601- 4G4	14,5 - 18,0	40
H07RN-F	4G6	0601- 4G6	16,5 - 22,0	54
H07RN-F	5G1,5	0601- 5G1,5	11,5 - 15,0	23
H07RN-F	5G2,5	0601- 5G2,5	13,5 - 17,0	36
A07RN-F	7G1,5	0602- 7G1,5	14,0 - 17,5	37
A07RN-F	7G2,5	0602- 7G2,5	16,5 - 20,0	52
A07RN-F	12G1,5	0602-12G1,5	18,0 - 23,0	57
A07RN-F	12G2,5	0602-12G2,5	18,5 - 26,5	80

Förskruvningar för rundkabel

Storlek [mm]	Kabel- förskruvning Art.nr	Kabel- diameter [mm]	Kontramutter Art.nr
20,4	020646-13,5	6 - 13,5	020657-13,5
22,5	020646-16	6 - 15	020657-16
28,3	020646-21	9 - 20	020657-21
37	020646-29	17 - 27	020657-29

Material: Hölje av slagålig plast; Tätning av oljebeständigt gummi;
Tryckbricka av förzinkad plåt.

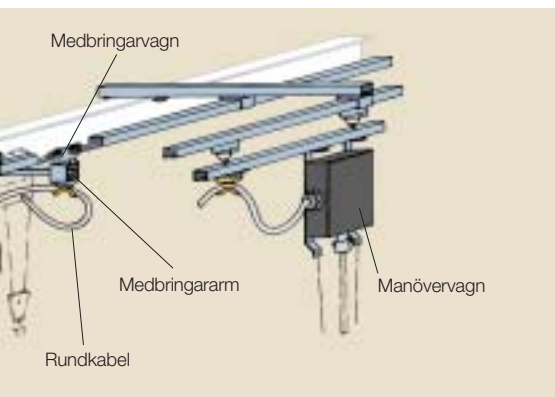

Manövervagnar

Manövervagn med industridon

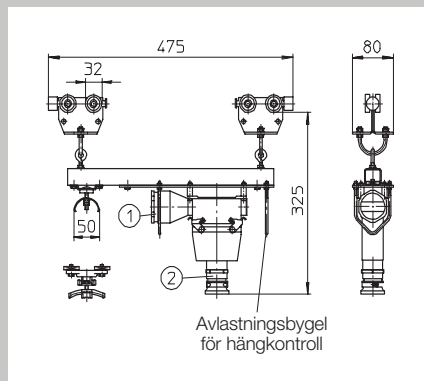

För nominellt 400 V; 16 A. Skyddsklass IP 55. Anslutning 2,5 mm².

Art.nr	För kabeltyp för	Antal ledare	Förskruvning [mm]		Last [kg]
			①	②	
024778-16	Plattkabel	16 + E	54	28,3	40
024778-24		24 + E		37,0	
024779-16	Rundkabel	16 + E	37	28,3	
024779-24		24 + E		37,0	

Tillbehör

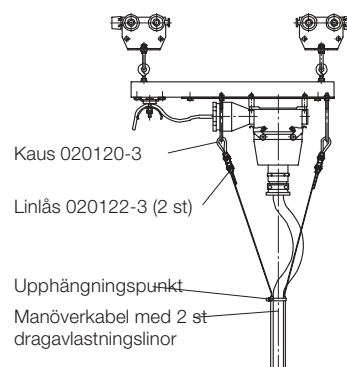

Manöverkabel av PVC med 2 st dragavlastningslinor av stål.

Typ: MTTY-O

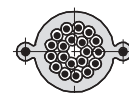

Manövervagn med kopplingslåda

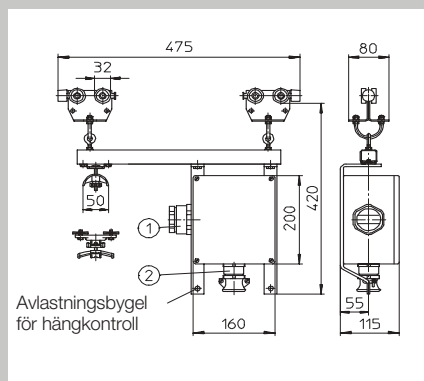

För nominellt 400 V; 16 A. Skyddsklass IP 54. Anslutning 4 mm².

Art.nr	För kabeltyp	Antal ledare	Förskruvning [mm]		Last [kg]
			①	②	
024774-16	Plattkabel	16 + E	54	28,3	40
024774-24		24 + E		37,0	
024775-16	Rundkabel	16 + E	37	28,3	
024775-24		24 + E		37,0	

Art.nr	Ledarantal och area [mm ²]	Storlek [mm]
0609-12X1,5	12 x 1,5	28,3
0609-16X1,5	16 x 1,5	
0609-20X1,5	20 x 1,5	37,0
0609-24X1,5	24 x 1,5	

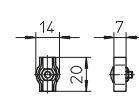
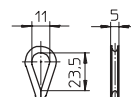

Kaus
Art.nr: 020120-3
Galv. stål

Linlås
Art.nr: 020122-3
Galv. stål

Önskar Ni ta del av vårt kompletta standardprogram inkl rostfria detaljer, begär vår huvudkatalog över Program 240.

solutions for a moving world

IDEMA Industriteknik AB
Box 141
801 03 GÄVLE

Besöksadress
Utmarksvägen 9
802 91 GÄVLE

Tel: 026-129700
Fax: 026-120404

www.idema.se
info@idema.se