

## Modulöversikt - Pushrar

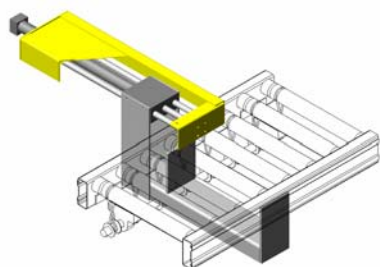

AX100 – Pusher, sidmonterad

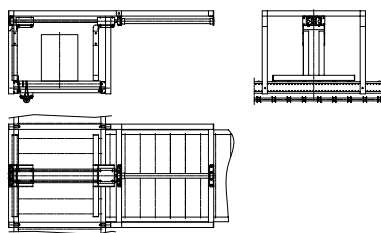

AX100 – Pusher, överliggande, pneumatisk

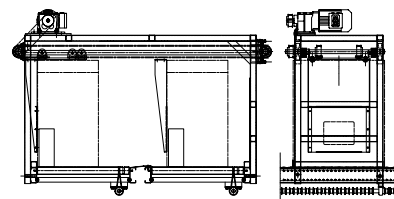

AX100 – Pusher, överliggande, elektrisk

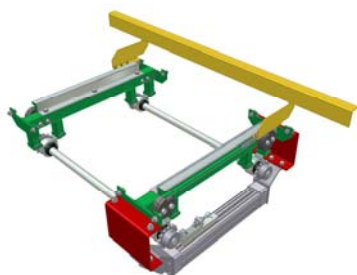

AX100 – Pusher, underliggande, pneumatisk

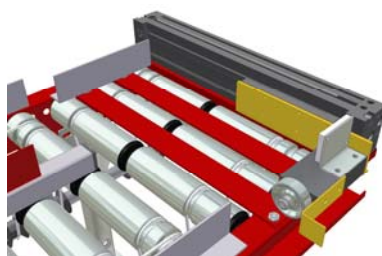

AX100 – Pusher, ändmonterad, pneumatisk

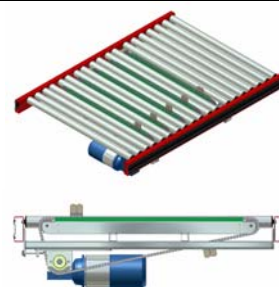

AX100 – Pusher, underliggande medbringarväxel

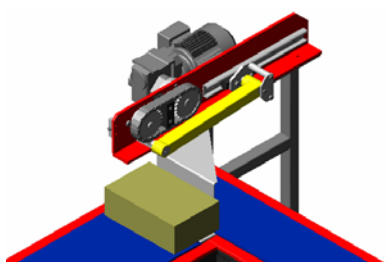

AX100 – Pusher, överliggande, motorpusher



AX100 – Pusherplåt med lucka. Till överliggande motorpusher

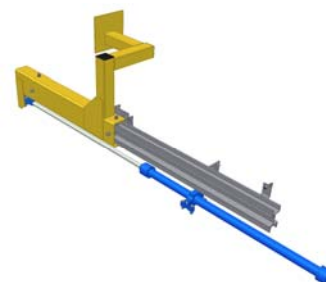

KE100 – Pusher, ändmonterad hydraulisk

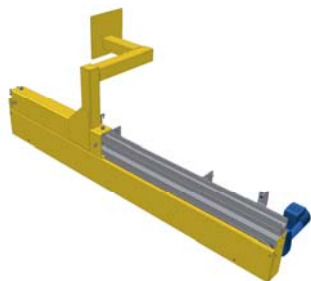

KE100 – Pusher, ändmonterad elektrisk

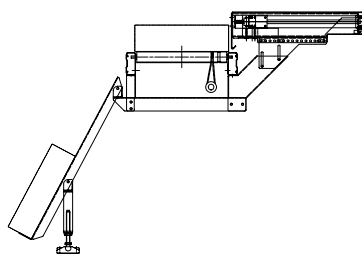

AX100 Rostfritt – Pusher, rejectpusher

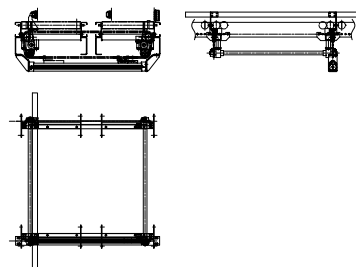

AX100 - Pusher, underliggande, pneumatisk

\* Datablad finns

## Modulöversikt - Pushrar

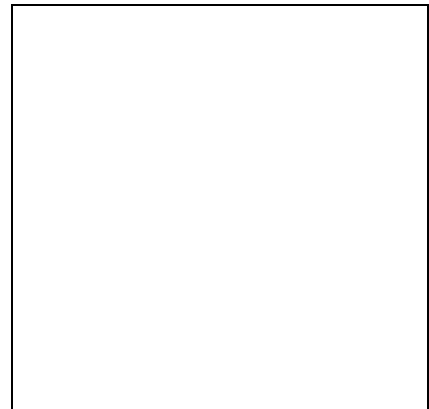
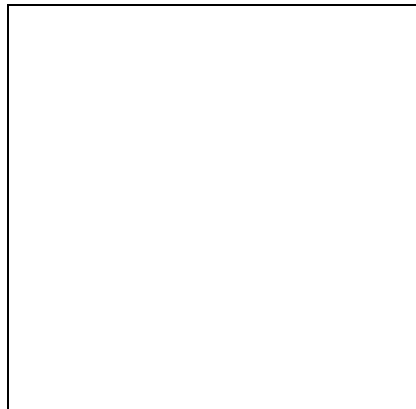
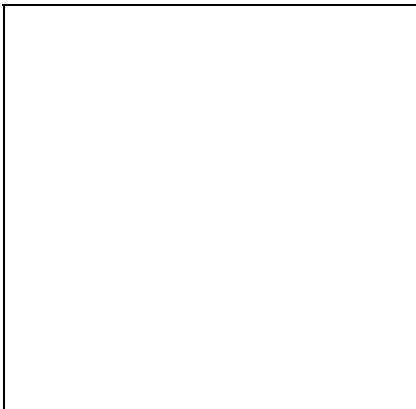
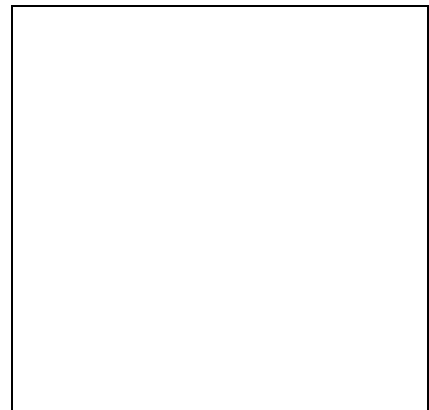
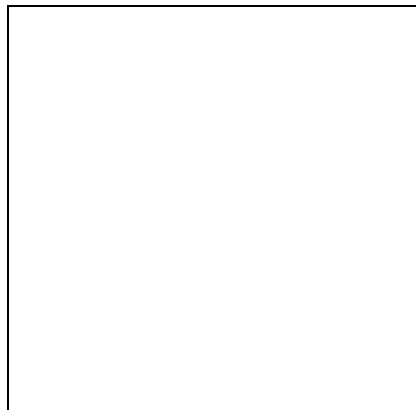
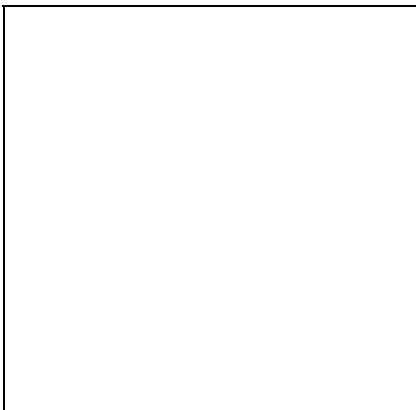
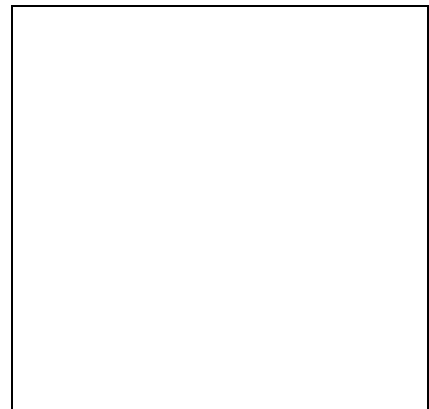
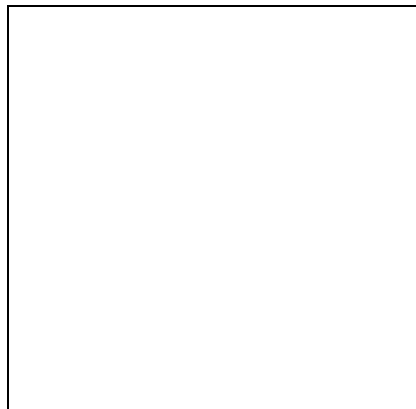
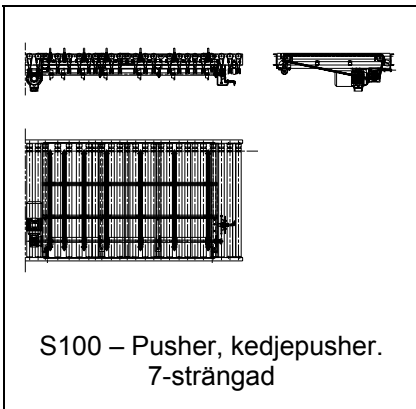
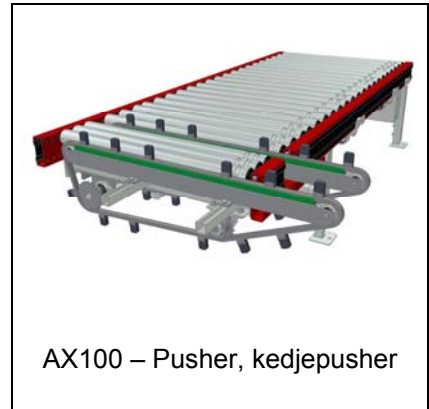
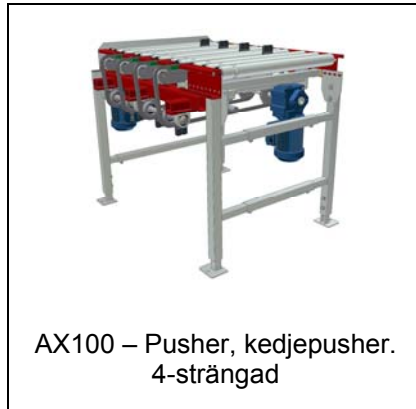
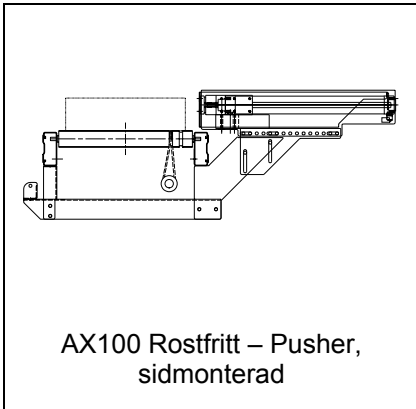

\* Datablad finns